

PLAN VIEW

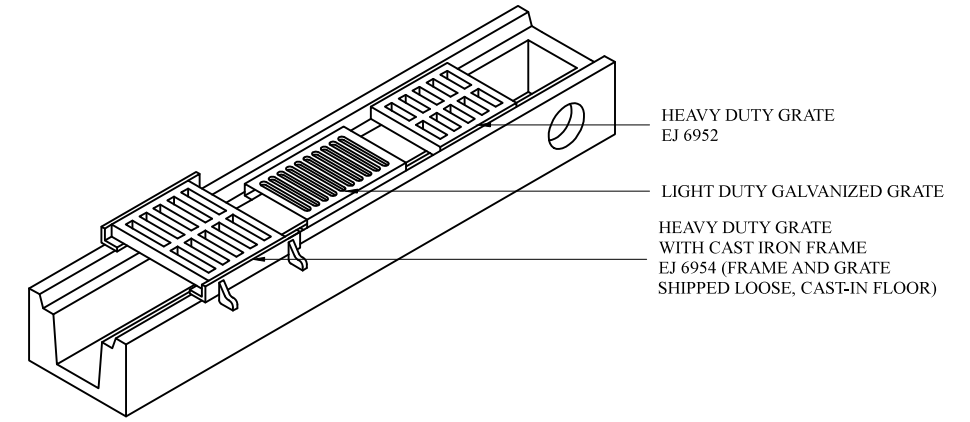

ISOMETRIC VIEW

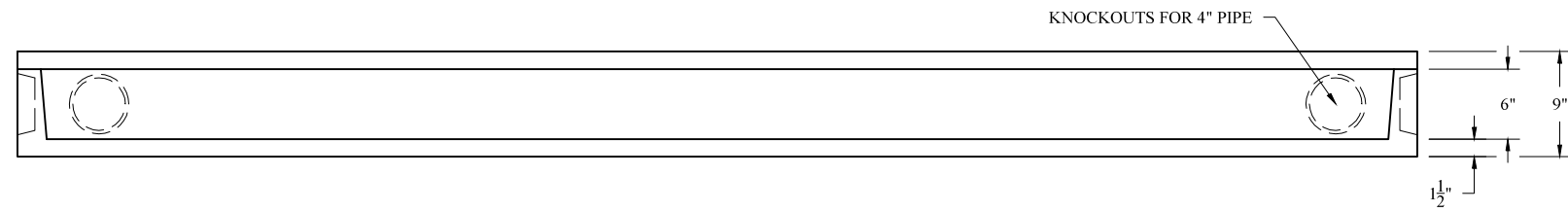

SECTION A-A

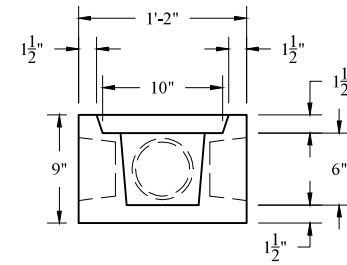

SECTION B-B

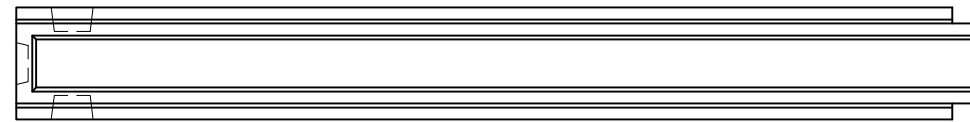

CLOSED END X SPIGOT

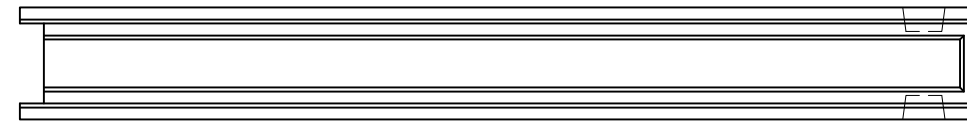

CLOSED END X BELL

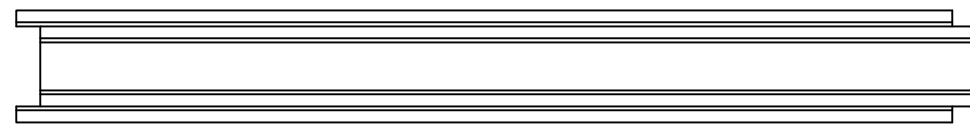

INTERMEDIATE (BELL X SPIGOT)

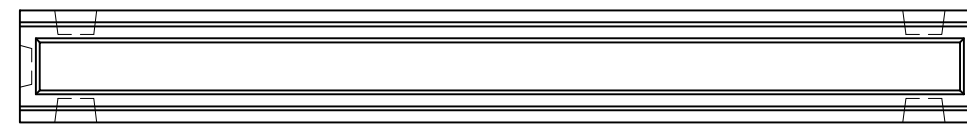

BOTH ENDS CLOSED

**NCI**  
 Norwalk Concrete Industries  
 80 Commerce Drive  
 Norwalk, Ohio 44857  
 www.nciprecast.com

Toll Free 800.733.3624  
 Phone 419.668.8167  
 Fax 419.663.0627

CONCRETE TRENCH DRAIN  
 10'-0" LONG

REVISIONS:	DWG:	DATE:	SHT. -
	S-0014-17	1.18.17	OF - JC